



**Numero perfetto.** Le tre dimensioni dell'ufficio di oggi: libertà, vivibilità, personalità. Una soluzione unica: la collezione Tre. Lunghi tavoli componibili, versatili elementi di servizio, colori e accessori che trasformano ogni posto di lavoro in un piccolo mondo personale. **A perfect number.** The three dimensions of the modern-day office: freedom, practicality and personality. A unique solution: the Tre collection. Long modular tables, versatile service units, colours and accessories that give each work station an individual touch. **Die perfekte Zahl.** Die drei Dimensionen im Büro von heute: Freiheit, Lebensqualität, Persönlichkeit. Eine Lösung: die Kollektion Tre. Lange, kombinierbare Tische, vielseitige Beistellelemente, Farben und Zubehör, die jeden Arbeitsplatz in eine kleine, individuelle Welt verwandeln. **Nombre parfait.** Les trois dimensions du bureau d'aujourd'hui : liberté, vivabilité, personnalité. Une solution unique : la collection Tre. Longs bureaux composables, éléments de service polyvalents, couleurs et accessoires qui transforment chaque poste de travail en un petit monde personnel. **Número perfecto.** Las tres dimensiones de la oficina de hoy: libertad, habitabilidad, personalidad. Una solución única: la colección Tre. Mesas largas componibles, elementos de servicio versátiles, colores y accesorios que transforman cada puesto de trabajo en un pequeño universo personal.



**Possibilità extra.**

Il tavolo "Extra Long" può raggiungere una lunghezza di 360 cm ed è proposto in una gamma completa di varianti: dalla semplice scrivania con fiancate, al tavolo a ponte da sovrapporre al tavolo di servizio per creare composizioni che estendono le tradizionali funzioni e valenze estetiche delle postazioni operative.

**Extra possibilities.**

The "Extra Long" table can be up to 360 cm in length and is available in a wide range of versions: from a simple desk with side panels to a bridging table that can be positioned over a service table to create configurations that extend the traditional functions and aesthetic values of work stations.

**Möglichkeit extra.**

Der Tisch "Extra Long" kann eine Länge von 360 cm erreichen und wird in einem kompletten Programm von Ausführungen angeboten: vom einfachen Schreibtisch mit Seitenteil bis zum Tisch, der als Brücke über dem Beistelltisch eingesetzt wird, um Kompositionen entstehen zu lassen, die Funktion und Ästhetik traditioneller Arbeitsplätze erweitern.

**Possibilités extra.**

Le bureau "Extra Long" peut atteindre une longueur de 360 cm et est proposé dans une gamme complète de variantes: du simple bureau avec piètements latéraux constitués d'un panneau plein, à la table en pont à superposer à la table de service, pour créer des compositions qui augmentent les fonctions traditionnelles et les qualités esthétiques des postes de travail.

**Posibilidades extra.**

La mesa "Extra Long" puede alcanzar una longitud de 360 cm y se propone en una gama completa de variantes: del simple escritorio con costados, a la mesa con configuración en forma de puente para superponer a la mesa de servicio y crear composiciones que amplían las funciones tradicionales y los valores estéticos de los puestos operativos.





## 106 **Molteplici sviluppi.**

L'architettura del posto di lavoro prende forma per accostamenti e sovrapposizioni di tavoli "Extra Long", schermi divisorii, cassettiere portanti ed elementi a giorno, in un libero gioco di piani, volumi, geometrie e colori.

### **Unlimited expansion.**

The architecture of the work station takes shape by placing "Extra Long" tables, divider screens, supporting drawer boxes and open units next to and over each other, in a free play of surfaces, volumes, geometries and colours.

### **Vielfältige Entwicklungen.**

Der Aufbau von Arbeitsplätzen nimmt Form an: durch Kombination und Überlagerung von Tischen "Extra Long", Trennschirmen, tragenden Schubladenkästen und offenen Schrankelementen, alles im beliebigen Spiel mit Platten, Volumen, Geometrien und Farben.

### **Développements multiples.**

L'architecture du poste de travail prend forme par juxtapositions et superpositions de bureaux "Extra Long", panneaux écran, caissons porteurs et éléments ouverts, en un libre jeu de plans, volumes, géométries et couleurs.

### **Desarrollos múltiples.**

La arquitectura del puesto de trabajo adquiere forma gracias a las combinaciones y a las superposiciones de las mesas "Extra Long", paneles separadores, cajoneras de soporte y elementos sin puertas, en un juego libre de planos, volúmenes, geometrías y colores.

## 107 **TRE COLLECTION**











**Colorata  
funzionalità.**

Il mobile di servizio offre una superficie da appoggio per tecnologie e materiali di lavoro da condividere con i colleghi, ma allo stesso tempo rappresenta un elemento estetico, introducendo la valenza espressiva di colori di tendenza: amaranto, verde e giallo, in abbinamento al grigio nebbia e al rovere.

**Colourful  
functionality.**

The service unit provides a surface on which to place office equipment and materials to be shared between co-workers, while at the same time enhancing overall appearance by introducing the expressive value of fashionable colours: amaranth, green and yellow, combined with misty grey and oak.

**Farbige  
Zweckmäßigkeit.**

Mit dem Beistellmöbel wird eine Auflagefläche für Technologien und Arbeitsunterlagen geboten, die mit Kollegen geteilt wird, aber gleichzeitig ist es ein ästhetisches Element, das eine neue, expressive Dimension durch trendige Farben hinzufügt: Amaranthrot, Grün und Gelb, in Verbindung mit Nebelgrau und Eiche.

**Fonctionnalité  
colorée.**

Le meuble de service offre une surface d'appui pour les équipements bureautiques et le matériel de travail à partager avec les collègues, mais il représente en même temps un élément esthétique introduisant la force expressive des couleurs mode: amarante, vert et jaune, associé au gris brouillard et au chêne.

**Funcionalidad  
coloreada.**

El mueble de servicio ofrece una superficie de apoyo para las tecnologías y los materiales de trabajo que se comparten con los compañeros de trabajo, pero que al mismo tiempo representa un elemento estético, introduciendo la característica expresividad de los colores de tendencia: granata, verde y amarillo, combinado con el gris niebla y el roble.



**Tre per tutti.** I tavoli sagomati permettono di creare delle composizioni multiple, capaci di riunire in un'unica postazione di lavoro, tutte le diverse valenze dell'ufficio contemporaneo: ergonomia e creatività, colore e rigore, modularità e personalizzazione.

**Three for all.** Shaped tables make it possible to create multiple configurations, combining all the advantages of the contemporary office in a single work station: ergonomic design and creativity, colour and clean lines, modularity and personalisation.

**Drei für alle.** Mit den besonders geformten Tischen können Mehrfachplätze zusammengestellt werden, um alle Anforderungen, die an ein modernes Büro gestellt werden, mit einer Arbeitsstation erfüllen zu können: Ergonomie und Kreativität, Farbe und Rigorosität, Modulbauweise und individuelle Gestaltung. **« Tre » pour tous.** Les bureaux non linéaires permettent de créer des compositions multiples, capables de réunir dans une unique poste de travail, toutes les qualités du bureau contemporain : ergonomie et créativité, couleur et rigueur, modularité et personnalisation. **Tre para todos.** Las mesas curvadas permiten crear composiciones múltiples, capaces de reunir en una estación única de trabajo, todas las fuerzas que califican la oficina contemporánea: ergonomía y creatividad, color y rigor, modularidad y personalización.





**Libere associazioni.**

Piani sagomati a 90° e 120°, top di raccordo, piani rettangolari anche su misura, basi metalliche a T o cilindriche si affiancano agli altri elementi della collezione: dai tavoli di servizio, ai contenitori, agli schermi divisorii, permettendo la massima libertà di progettazione, organizzazione e utilizzo dello spazio.

**Free associations.**

Shaped surfaces at 90° and 120°, connecting tops, rectangular surfaces which can also be made to measure and metal 'T'-shaped or cylindrical bases combine with other components of the collection: from service tables to storage units and divider screens. They allow maximum freedom for designing, organising and using space.

**Freie Assoziationen.**

Platten auf 90° und auf 120°, Verbindungsplatten, rechteckige Platten auch nach Maß, metallische Untergestelle aus T-Profil oder zylindrisch, können mit anderen Elementen der Kollektion verbunden werden: Beistelltische, Schrankelemente und Trennschirme geben maximale Freiheit in Planung, Organisation und Nutzung von Räumen.

**Associations libres.**

Plans découpés à 90° et à 120°, plans de liaison, plans rectangulaires également sur mesure, piètements métalliques en T ou cylindriques, ils se juxtaposent aux autres éléments de la collection : des tables de service, aux armoires, aux panneaux écran, permettant la plus grande liberté de projet, d'organisation et d'utilisation de l'espace.

**Libres asociaciones.**

Tableros curvados de 90° y 120°, encimera de unión, tableros rectangulares también a medida, bases metálicas en forma de T o cilíndricas, se combinan con otros elementos de la colección: mesas de servicio, armarios y paneles separadores, permitiendo la máxima libertad de proyecto, organización y uso del espacio.





**124 Atmosfere leggere.**

L'originale decoro stilizzato può essere realizzato anche sugli ampi tavoli da riunione rettangolari, di lunghezza 240 cm, nonché sullo schienale delle sedute coordinate, realizzate con un'unica scocca in multistrato curvato: un segno di naturale calore e di luminosa leggerezza.

**Light atmospheres.**

The unusual, stylised decoration is also available on large, 240 cm long meeting tables and on the backrests of coordinating chairs, made using a one-piece shell in curved plywood: a hint of natural warmth and bright airiness.

**Ein Hauch Schwerelosigkeit.**

Ebenfalls realisierbar ist die originelle, stilisierte Dekoration auf den großzügigen, rechteckigen Konferenztischen, Länge 240 cm, sowie auf dem Rückteil der dazu passenden Sitzmöbel mit durchgehender Sitzschale aus gebogener Mehrschichtplatte: ein Zeichen für natürliche Wärme und helle Leichtigkeit.

**Atmosphères légères.**

Le décor original stylisé peut être réalisé également sur les grandes tables de réunion rectangulaires, de 240 cm de longueur, ainsi que sur le dossier des sièges assortis, réalisés avec une coque unique en multiplis courbé : un signe de chaleur et de légèreté lumineuse.

**Atmósferas leves.**

La decoración estilizada original puede ser realizada también en las amplias mesas de reunión rectangulares, de 240 cm de longitud, así como en el respaldo de los asientos coordinados, realizados con una estructura única en estratificado curvado: un signo de natural calidez y luminosa ligereza.

**125 TRE COLLECTION**



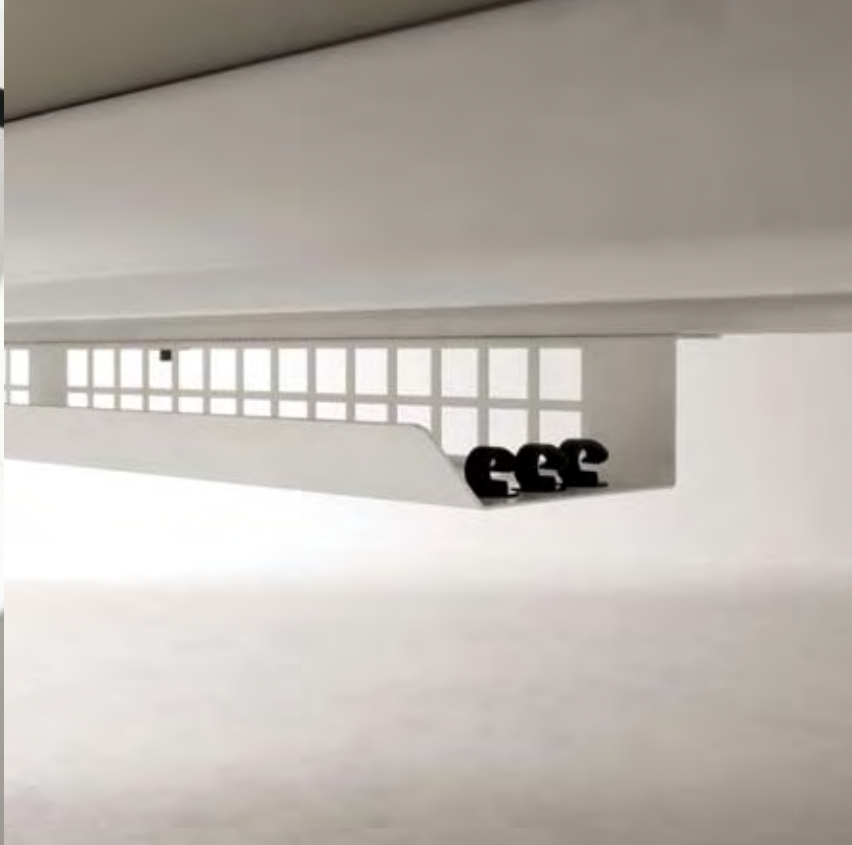

#### **Tecnologie essenziali.**

Parte integrante del lavoro d'ufficio, la tecnologia si inserisce con discrezione nel design della collezione Tre, sfruttando una serie di soluzioni attentamente studiate per unire funzionalità, accessibilità e immediatezza: canaline trasparenti, vaschette sottopiano, cestelli portacavi, supporti porta CPU.

#### **Technology made simple.**

Technology, an integral part of office work, blends discretely into the design of the Tre collection, using a number of solutions carefully devised to combine functionality, accessibility and immediateness: transparent ducting, storage trays under the top, cable racks and CPU holders.

#### **Essentielle Technologien.**

Technologie, ein wesentlicher Teil der Arbeit im Büro, fügt sich mit Diskretion in das Design der Kollektion Tre ein und nutzt dabei eine Reihe sorgfältig entwickelter Lösungen, die Funktionalität, Zugänglichkeit und Unmittelbarkeit garantieren: transparente Kabelkanäle, Schalen unter Tischplatten, Kabelkörbe, Computer-Halterung.

#### **Technologies essentielles.**

Partie intégrante du travail de bureau, la technologie s'insère avec discrétion dans le design de la collection Tre, en exploitant une série de solutions étudiées attentivement pour associer la fonctionnalité, l'accessibilité et la rapidité : goulottes transparentes, bacs sous le plan, paniers pour câbles, supports pour unité centrale.

#### **Tecnologías esenciales.**

Parte integrante del trabajo de oficina, la tecnología entra discretamente en el diseño de la colección Tre, aprovechando una serie de soluciones estudiadas atentamente para unir funcionalidad, accesibilidad e inmediatez: canales transparentes, bandejas debajo del tablero, cestas portacables, soportes para CPU.



#### Organizzare le idee.

Un'ampia proposta di classificatori e contenitori soddisfa tutte le esigenze pratiche ed estetiche dello spazio ufficio: a giorno, con ante in legno oppure in vetro. Sono inoltre possibili composizioni multiple di contenitori affiancati, sui quali vengono posizionati degli appositi top di finitura dai bordi arrotondati.

#### Organising ideas.

A wide range of filing units and cabinets meet all the practical and aesthetic needs in the office: open, with wood or glass doors. Several cabinets can also be placed side-by-side and covered with special, rounded-edge finishing tops to create multiple configurations.

#### Ideen organisieren.

Durch ein breites Angebot von Akten- und Schrankmöbeln können sowohl die praktischen als auch ästhetischen Anforderungen an den modernen Bürobereich erfüllt werden: offen, mit Holz- oder Glastüren. Außerdem können Schrankelemente zu mehrfachen Kompositionen aneinandergereiht und durch Oberplatten mit gerundeten Kanten abgeschlossen werden.

#### Organiser les idées.

Une proposition variée de classeurs et armoires satisfait toutes les exigences pratiques et esthétiques de l'espace bureau : sans portes, avec portes, avec portes en bois ou en verre. Possibilité de compositions multiples d'armoires juxtaposées sur lesquelles sont placés des plateaux de finition avec bords arrondis.

#### Organizar las ideas.

Una amplia propuesta de carpeteros y armarios ofrece una respuesta a todas las exigencias prácticas y estéticas del espacio de oficina: sin puertas, con puertas de madera o de vidrio. Además, se pueden formar composiciones múltiples de armarios adosados, sobre los cuales se colocan las encimeras de acabado con cantos redondeados.

Tavolo rettangolare\_Rectangular table\_  
Rechteckiger Tisch\_Table rectangulaire\_Mesa  
rectangular

P80 H72  
64-1R20 L 200 64-1R32 L 320  
64-1R24 L 240 64-1R36 L 360  
64-1R28 L 280

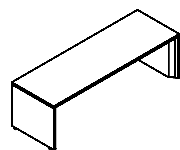

Tavolo rettangolare decorato\_Decorated  
rectangular table\_Rechteckiger Tisch in  
Dekorausführung\_Bureau rectangulaire  
décoré\_Mesa rectangular decorada

P80 H72  
64-1R21 L 200 64-1R33 L 320  
64-1R25 L 240 64-1R37 L 360  
64-1R29 L 280

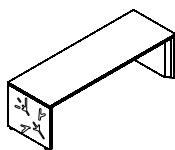

Tavolo penisola\_Peninsula table\_Halbinsel-  
Tisch\_Bureau en épi\_Ala de extensión de  
mesa

P80 H72  
64-1R40 L 200  
64-1R44 L 240  
64-1R48 L 280

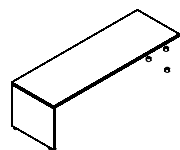

Tavolo penisola decorato\_Decorated  
peninsula table\_Halbinsel-Tisch in  
Dekorausführung\_Bureau en épi décoré\_Ala  
de extensión decorada

P80 H72  
64-1R41 L 200  
64-1R45 L 240  
64-1R49 L 280

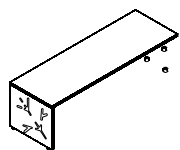

Tavolo di servizio\_Side table\_Beistelltisch\_  
Table de service\_Mesa de servicio

P40 H62  
64-1R60 L 200 64-1R72 L 320  
64-1R64 L 240 64-1R76 L 360  
64-1R68 L 280

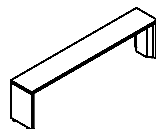

Tavolo di servizio decorato\_Beistelltisch in  
Dekorausführung\_Decorated side table\_  
Table de service décorée\_Mesa de servicio  
decorada

P40 H62  
64-1R61 L 200 64-1R73 L 320  
64-1R65 L 240 64-1R77 L 360  
64-1R69 L 280

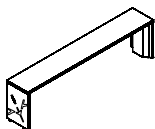

Carter per fianchi tavoli P80\_Casing for sides  
of P80 tables\_Seitenabdeckung für Tische  
P80\_Enjoliveur pour piétements bureaux  
P80\_Panel de cubierta para los costados de  
la mesa P80

L74 P5 H66  
64-BR96 pz. 1

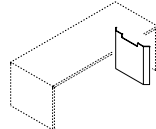

Carter per fianchi tavoli P40\_Casing for sides  
of P40 tables\_Seitenabdeckung für Tische  
P40\_Enjoliveur pour piétements bureaux  
P40\_Panel de cubierta para los costados de  
la mesa P40

L34 P5 H56  
64-BR98 pz. 1

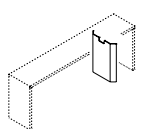

Cassettiera portante, 3 cassetti\_Supporting  
drawer box, 3 drawers\_Tragender  
Schubladenkasten, 3 Laden\_Caisson  
porteur, 3 tiroirs\_Cajonera de soporte, 3  
cajones

L42 P57 H58+S  
64-6R89

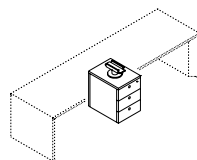

Cassettiera portante, 1cassetto/  
1classif.\_Supporting drawer box, 1 drawer/  
1 filing drawer\_Tragender  
Schubladenkasten, 1 Lade/1 Karteiausz\_  
Caisson porteur, 1 tiroir/1 classeur\_Cajonera  
de soporte, 1 cajón/1 carpetero

L42 P57 H58+S  
64-6R90

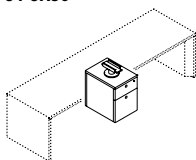

Base per tavoli Extra long H62/72\_Base for  
Extra Long tables H62/72\_Untergestell für  
Tische Extra Long H62/72\_Piètement pour  
bureaux Extra Long H62/72\_Apoyo para  
mesas Extra Long, H62/72

Ø 6 H72 64-BR87  
Ø 6 H62 64-BR88

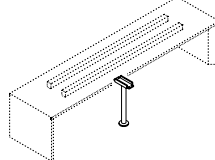

Mobile a giorno, monofronte\_Open-fronted  
unit with single front panel\_Offenes  
Element, eine Front\_Armoire ouverte 1  
face\_Armario sin puertas, frente único

L80 P40 H41  
64-7R18

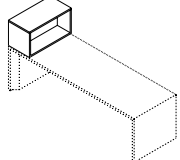

Mobile bifronte (divisorio plexiglas)\_Unit  
with double front panel (Plexiglas partition)\_  
Element mit zwei Fronten (Trennwand aus  
Plexiglas)\_Armoire ouverte 2 faces  
séparation en plexiglas\_Armario doble  
frente (divisorio en plexiglas)

L80 P40 H41  
64-7R28

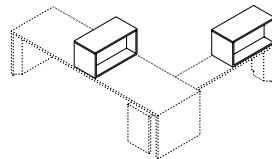

Mobile sospeso monofronte\_Suspended  
unit with single front panel\_Hängeelement  
eine Front\_Meuble suspendu 1 face\_  
Armario suspendido frente único

L80 P40 H41  
64-7R38

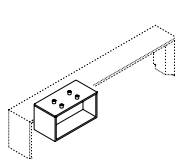

Pensile a muro, anta scorrevole\_Wall unit,  
sliding door\_Hängeschrank, mit Schiebetür\_  
Meuble haut, porte coulissante\_Mueble alto,  
puerta corredera

L160 P32 H41  
64-7R48

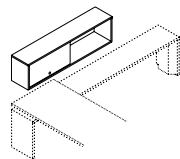

Libreria per tavoli penisola\_Bookcase for  
peninsula tables\_Bücherschrank für  
Halbinsel-Tische\_Meuble bibliothèque pour  
bureaux en épi\_Librería para alas de  
extensión de mesa

L240 P40 H62  
64-7R58

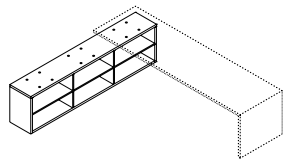

Esempi di composizioni\_Combination  
example\_Anbau-Beispiele\_Exemples de  
compositions\_Ejemplos de composición

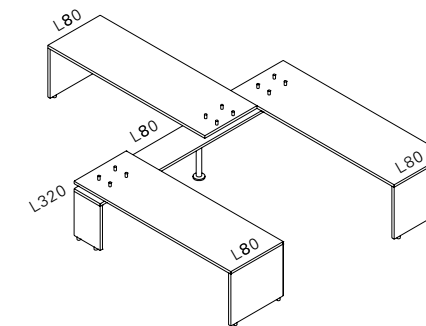
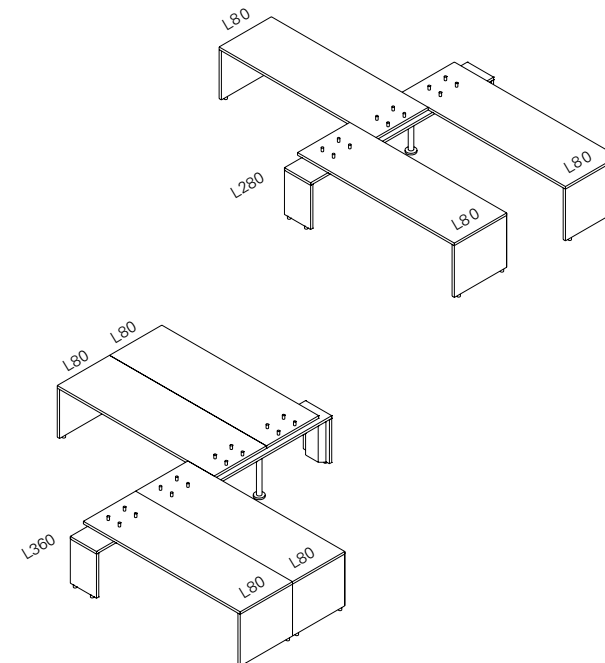
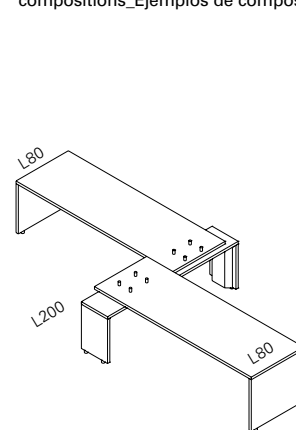

Consigli d'uso degli accessori, in  
composizioni con tavoli molto lunghi\_  
Recommended uses of accessories in  
compositions with extra long tables\_  
Empfehlung für den Einsatz von Zubehör  
bei sehr langen Tischkombinationen\_  
Conseils d'utilisation des accessoires, dans  
des compositions avec bureaux très longs\_  
Consejos para el uso de accesorios en  
composiciones con mesas muy largas

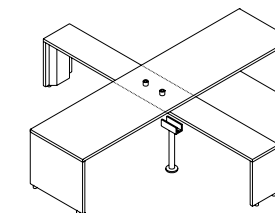
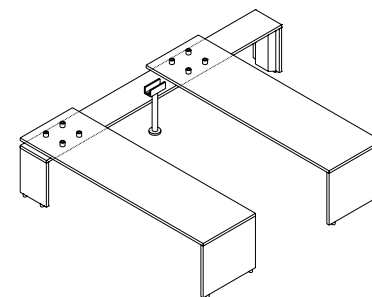
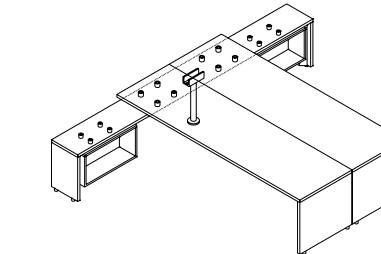
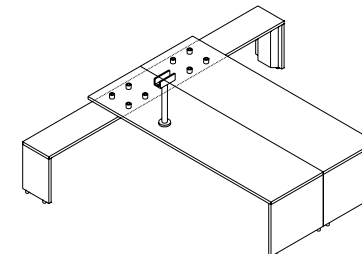

Tavolo rettangolare\_Rectangular desk\_  
Rechteckiger Tisch\_Bureau rectangulaire\_  
Mesa rectangular

P80 H72  
64-1R08 L 80 64-1R16 L 160  
64-1R12 L 120 64-1R18 L 180  
64-1R14 L 140

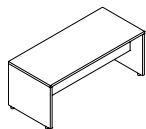

Tavolo rettangolare decorato\_Decorated  
rectangular table\_Rechteckiger Tisch in  
Dekorführung\_Bureau rectangulaire  
décoré\_Mesa rectangular decorada

P80 H72  
64-1R09 L 80 64-1R17 L 160  
64-1R13 L 120 64-1R19 L 180  
64-1R15 L 140

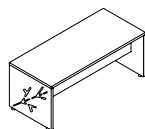

(\*)Tavolo sagomato (90°)\_Curved desk  
(90°)\_Bogenförmiger Tisch (90°)\_Bureau  
courbé (90°)\_Mesa curvada (90°)

P140 H72 64-2R80  
P160 H72 64-2R81

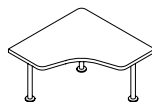

Tavolo sagomato (90°)\_Curved desk (90°)\_  
Bogenförmiger Tisch (90°)\_Bureau courbé  
(90°)\_Mesa curvada (90°)

P140 H72 64-2R78  
P160 H72 64-2R79

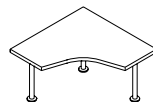

(\*) Tavolo sagomato (90°)\_Curved desk  
(90°)\_Bogenförmiger Tisch (90°)\_Bureau  
courbé (90°)\_Mesa curvada (90°)

P140 H72 64-2R82  
P160 H72 64-2R83

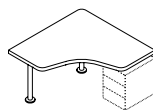

Tavolo sagomato (90°)\_Curved desk (90°)\_  
Bogenförmiger Tisch (90°)\_Bureau courbé  
(90°)\_Mesa curvada (90°)

P140 H72 64-2R84  
P160 H72 64-2R85

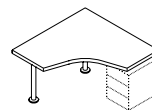

(\*) Tavolo sagomato (120°)\_Curved desk  
(120°)\_Bogenförmiger Tisch (120°)\_Bureau  
courbé (120°)\_Mesa curvada (120°)

L209 P70- 111 H72  
64-2R90

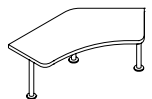

Tavolo sagomato (120°)\_Curved desk (120°)\_  
Bogenförmiger Tisch (120°)\_Bureau courbé  
(120°)\_Mesa curvada (120°)

L209 P70- 111 H72  
64-2R96

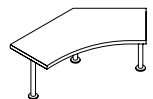

(\*) Tavolo sagomato (120°)\_Curved desk  
(120°)\_Bogenförmiger Tisch (120°)\_Bureau  
courbé (120°)\_Mesa curvada (120°)

L209 P70-111 H72  
64-2R91

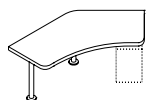

Tavolo sagomato (120°)\_Curved desk (120°)\_  
Bogenförmiger Tisch (120°)\_Bureau courbé  
(120°)\_Mesa curvada (120°)

L209 P70 -111 H72  
64-2R97

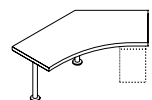

Tavolo autonomo\_Free-standing table\_  
Freistehender Tisch\_Bureau autonome\_  
Mesa autónoma

L120-60 P120-60 H72  
64-2R92

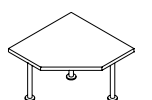

Tavolo di collegamento\_Connecting table\_  
Verbindungstisch\_Bureau de liaison\_Mesa  
de unión

L120-60 P120-60 H72  
64-2R93

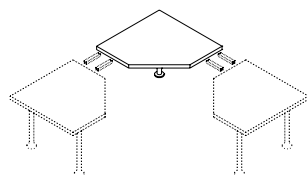

Piano di collegamento 90°\_90° connecting  
top\_Verbindungsplatte 90°\_Plan de liaison  
90°\_Módulo de unión 90°

P80  
64-5R02

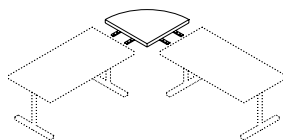

Piano terminale\_End unit\_Abschlussplatte\_  
Plan d'extension\_Módulo terminal de  
extensión

L80 P40  
64-5R03

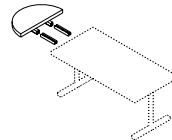

Tavolo rettangolare\_Rectangular desk\_  
Rechteckiger Tisch\_Bureau rectangulaire\_  
Mesa rectangular

P80 H72  
64-2R08 L 80 64-2R16 L 160  
64-2R12 L 120 64-2R18 L 180  
64-2R14 L 140

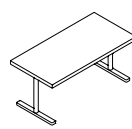

Tavolo intermedio\_Bureau intermédiaire\_  
Intermediate desk\_Bureau intermédiaire\_  
Mesa intermedia

P80 H72  
64-2R58 L 80 64-2R66 L 160  
64-2R62 L 120 64-2R68 L 180  
64-2R64 L 140

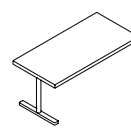

Tavolo dattilo\_Typing desk\_  
Schreibmaschinentisch\_Table dactylo\_Mesa  
dactilografía

P60 H72  
64-2R30 L 80 64-2R38 L 160  
64-2R31 L 100 64-2R40 L 180  
64-2R32 L 120

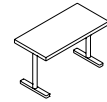

Tavolo intermedio\_Intermediate desk\_  
Zwischentisch\_Bureau intermédiaire\_Mesa  
intermedia

P60 H72  
64-2R40 L 80 64-2R48 L 160  
64-2R41 L 100 64-2R50 L 180  
64-2R42 L 120

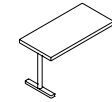

Cassettiera a 3 cassetti\_Drawer box with 3  
drawers\_Schubladenkasten mit 3 Laden\_  
Caisson avec 3 tiroirs\_Cajonera de 3 cajones

L42 P57 H58  
64-6R07



Cassettiera, 1cassetto/1classif.\_Drawer box,  
1 drawer/1 filing drawer\_Schubladenkasten,  
1 Lade/1 Karteiauszug\_Caisson, 1 tiroir/1  
classeur\_Cajonera, 1 cajón,1 carpetero

L42 P57 H58  
64-6R08



Cassettiera portante, 3 cassetti\_Supporting  
drawer box, 3 drawers\_Tragender  
Schubladenkasten, 3 Laden\_Caisson  
porteur, 3 tiroirs\_Cajonera de soporte, 3  
cajones

L42 P57 H58+S  
64-6R87

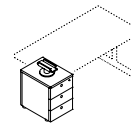

Cassettiera portante, 1 cassetto/1 classif. \_  
Supporting drawer box, 1 drawer/1 filing  
drawer\_Tragender Schubladenkasten,  
1 Lade/1 Karteiauszug\_Caisson porteur,  
1 tiroir/1 classeur\_Cajonera de soporte,  
1 cajón/1 carpetero

L42 P57 H58+S  
64-6R88

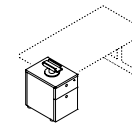

Set di 4 piedini fissi\_Set of 4 fixed feet\_  
Garnitur 4 fixe Füße\_Jeu de 4 pieds fixes\_  
Juego de 4 pies fijos

Ø 5 H1,7  
53-9M93

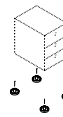

Tavolo riunione\_Conference table\_  
Konferenztisch\_Table de réunion\_Mesa de  
reunión

P120 H72 L240  
64-3R44

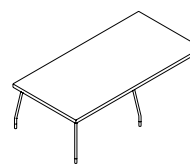

Tavolo riunione decorato\_Decorated  
conference table\_Konferenztisch in  
Dekorführung\_Mesa de reunión  
decorada\_Mesa de reuniones

P120 H72 L240  
64-3R45

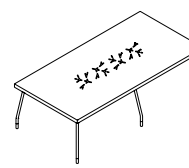

Tavolo rettangolare\_Rectangular table\_  
Rechteckiger Tisch\_Table rectangulaire\_Mesa  
rectangular

P80 H72  
64-3R08 L 80 64-3R16 L 160  
64-3R12 L 120 64-3R14 L 140

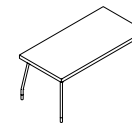

Tavolo rettangolare\_Rectangular table\_  
Rechteckiger Tisch\_Table rectangulaire\_Mesa  
rectangular

P100 H72  
64-3R24 L 140 64-3R26 L 160

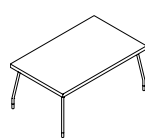

Tavolo con ruote\_Table with casters\_Tisch  
mit Rollen\_Table avec roulettes\_Mesa con  
ruedas

P80 H72  
64-3R09 L 80 64-3R17 L 160  
64-3R13 L 120 64-3R15 L 140

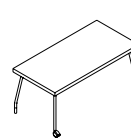

Tavolo con ruote\_Table with casters\_Tisch  
mit Rollen\_Table avec roulettes\_Mesa con  
ruedas

P100 H72  
64-3R25 L 140 64-3R27 L 160

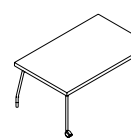

Piano rettangolare\_Rectangular top\_  
Rechteckige Platte\_Plateau rectangulaire\_  
Tablero rectangular

P80  
64-PR20 L 80 64-PR22 L 120 64-PR24 L 140 64-PR26 L 160 64-PR28 L 180  
P60  
64-PR44 L 80 64-PR45 L 100 64-PR46 L 120

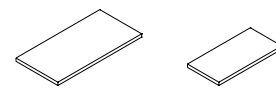

(\*) Non disponibile per il mercato francese  
Not available for the French market  
Für Frankreich nicht erhältlich  
Pas disponible pour le marché français  
No disponible para el mercado francés

Tavolo tondo\_Round table\_Runder Tisch\_  
Table ronde\_Mesa redonda

Ø90 H72  
64-3R31



Tavolo tondo con ruote\_Round table with  
casters\_Runder Tisch mit Rollen\_Table ronde  
avec roulettes\_Mesa redonda con ruedas

Ø90 H72  
64-3R41



Tavolo tondo\_Round table\_Runder Tisch\_  
Table ronde\_Mesa redonda

Ø120 H72  
64-3R32



Tavolo ovale\_Oval table\_Ovaler Tisch\_Table  
ovale\_Mesa ovalada

L140 P80 H72  
64-3R33



Tavolo rettangolare, regolabile\_Rectangular  
table, adjustable\_Rechteckiger Tisch,  
verstellbar\_Bureau rectangulaire, réglable\_  
Mesa rectangular, regulable

P80 H72-120  
64-TR14 L 140  
64-TR16 L 160  
220V ~50Hz 400W

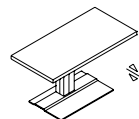

Tavolo ovale, regolabile  
Oval table, adjustable\_Ovaler Tisch,  
verstellbar\_Bureau ovale, réglable\_Mesa  
ovalada, regulable

P80 H72-120  
64-TR26 L 160  
220V ~50Hz 400W

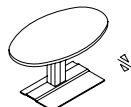

Tavolo sagomato, regolabile\_Curved table,  
adjustable\_Bogenförmiger Tisch,  
verstellbar\_Bureau courbe, réglable\_Mesa  
curvada, regulable

L160 P80 H72-120  
64-TR36  
220V ~50Hz 400W

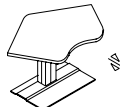

Piano per CPU  
Computer stand\_Computer-Auflageplatte\_  
Plateau pour ordinateur\_Soporte para  
ordenador

L45 P22 H57,5  
64-9R92

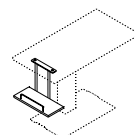

Schermo per CPU\_Computer screening  
panel\_Abschirmung für Computer\_Panneau  
pour ordinateur\_Panel para ordenador

L19 P5 H40  
64-9R59

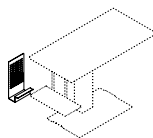

Pannello frontale metallico\_Metal front  
panel\_Metallisches Frontpaneel\_Panneau  
frontal métallique\_Panel frontal metálico

L100 P8 H32,5  
64-9R60

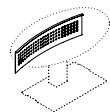

Piano di lavoro sagomato (90°)\_Curved  
worktop (90°)\_Arbeitsplatte, bogenförmig (90°)\_  
Plan de travail courbe (90°)\_Tablero curvado  
(90°)

L140 P140 64-PR32  
L160 P160 64-PR33

*Non disponibile per il mercato francese  
Not available for the french market  
Für Frankreich nicht erhältlich  
Pas disponible pour le marché français  
No disponible para el mercado francés*



Piano di lavoro sagomato (90°)\_Curved  
worktop (90°)\_Arbeitsplatte, bogenförmig  
(90°)\_Plan de travail courbe (90°)\_Tablero  
curvado (90°)

L140 P140 64-PR30  
L160 P160 64-PR31

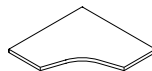

Piano di lavoro sagomato (120°)\_Curved  
worktop (120°)\_Arbeitsplatte, bogenförmig  
(120°)\_Plan de travail courbe (120°)  
Tablero curvado (120°)

L209 P70-111  
64-PR34

*Non disponibile per il mercato francese  
Not available for the french market  
Für Frankreich nicht erhältlich  
Pas disponible pour le marché français  
No disponible para el mercado francés*



Piano di lavoro sagomato (120°)\_Curved  
worktop (120°)\_Arbeitsplatte, bogenförmig  
(120°)\_Plan de travail courbe (120°)  
Tablero curvado (120°)

L209 P70-111  
64-PR36



Piano di lavoro\_Worktop\_Arbeitsplatte\_Plan  
de travail\_Tablero

L120-60 P120-60  
64-PR35

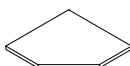

Piano di lavoro a misura\_Custom worktop\_  
Arbeitsplatte nach Maß\_Plan de travail sur  
mesure\_Tablero a medida

H 6,5 L. max.300cm  
64-PR10 P 100  
64-PR08 P 80  
64-PR06 P 60

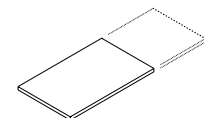

Base cilindrica\_Cylindrical base\_  
Zylinderförmiges Fußgestell\_Piètement  
cylindrique\_Apoyo cilíndrico

Ø6 H72  
64-BR84

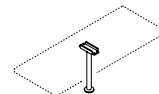

Base cilindrica, regolabile\_Cylindrical base,  
adjustable\_Zylinderförmiges Fußgestell,  
verstellbar\_Piètement cylindrique, réglable\_  
Apoyo cilíndrico, regulable

Ø6 H67-77  
64-BR94

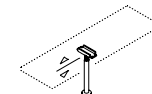

Base a T\_T-shaped base\_Fußgestell T-förmig\_  
Piètement T\_Apoyo en T

L12 P68 H72  
64-BR80  
64-BR81 pezzi 1  
pezzi 2

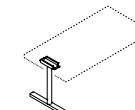

Base a T ridotta\_Reduced T-shaped base\_  
Fußgestell T-förmig, reduziert\_Piètement T  
réduit\_Apoyo en T reducido

L12 P50 H72  
64-BR82  
64-BR83 pezzi 1  
pezzi 2

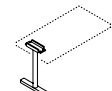

Base a T, regolabile\_T-shaped base,  
adjustable\_Fußgestell T-förmig, verstellbar\_  
Piètement T, réglable\_Apoyo en T regulable

L12 P68 H67-77  
64-BR90  
64-BR91 pezzi 1  
pezzi 2

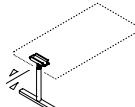

Base a T ridotta, regolabile\_Reduced  
T-shaped base, adjustable\_Fußgestell  
T-förmig reduziert, verstellbar\_Piètement T  
réduit, réglable\_Apoyo en T reducido,  
regulable

L12 P50 H67-77  
64-BR92  
64-BR93 pezzi 1  
pezzi 2

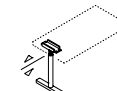

Pannello schermo vetro sabbato\_Matt-finish  
screen panel\_Abschirmpaneel aus Mattglas\_  
Panneau écran satiné\_Panel separador  
vidrio arenado

H40 P0,5  
64-4R22 L 119 64-4R28 L 179  
64-4R24 L 139 64-4R30 L 199  
64-4R26 L 159

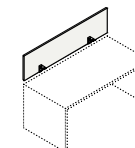

Pannello schermo nobilitato\_Melamine  
screen panel\_Melamin-Abschirmpaneel\_  
Panneau écran mélaminé\_Panel separador  
melamínico

H50 P1,8  
64-4R52 L 119 64-4R58 L 179  
64-4R54 L 139 64-4R60 L 199  
64-4R56 L 159

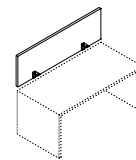

Pannello schermo nobilitato\_Melamine  
screen panel\_Melamin-Abschirmpaneel\_  
Panneau écran mélaminé\_Panel separador  
melamínico

H50 P1,8  
64-4R62 L 119 64-4R68 L 179  
64-4R64 L 139 64-4R70 L 199  
64-4R66 L 159

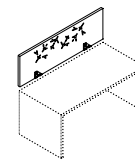

Pannello con binario alluminio\_Panel with  
aluminium rail\_Paneel mit  
Aluminiumschiene\_Panneau avec rail en  
aluminium\_Panel con guía en aluminio

H50 P2,8  
64-4R82 L 119 64-4R88 L 179  
64-4R84 L 139 64-4R90 L 199  
64-4R86 L 159

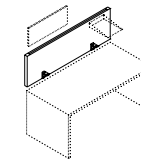

Pannello schermo bifronte\_Double sided  
screen pane\_Doppelseitiges  
Abschirmpaneel\_Panneau écran biface  
Panel separador doble frente

H50 P1,8  
64-4R53 L 119 64-4R59 L 179  
64-4R55 L 139 64-4R61 L 199  
64-4R57 L 159

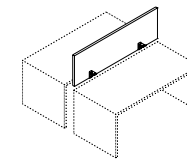

Pannello schermo bifronte\_Double sided  
screen pane\_Doppelseitiges  
Abschirmpaneel\_Panneau écran biface  
Panel separador doble frente

H50 P1,8  
64-4R63 L 119 64-4R69 L 179  
64-4R65 L 139 64-4R71 L 199  
64-4R67 L 159

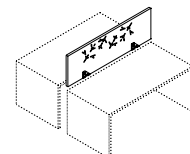

Pannello schermo bifronte\_Double sided  
screen pane\_Doppelseitiges  
Abschirmpaneel\_Panneau écran biface  
Panel separador doble frente

H50 P2,8  
64-4R83 L 119 64-4R89 L 179  
64-4R85 L 139 64-4R91 L 199  
64-4R87 L 159

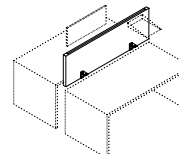

Contenitore a giorno\_Open-fronted cabinet\_  
Offener Schrank\_Armoire ouverte\_Armario  
sin puertas

L45 P43  
64-7R00 H 81,7  
64-7R10 H 121,7  
64-7R20 H 161,7

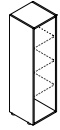

Contenitore anta legno (dx)\_Cabinet with  
wooden door (rh)\_Schrank mit Holztüre (re)\_  
Armoire porte bois (d)\_Armario puerta de  
madera (dx)

L45 P45  
Dx  
64-7R04 H 81,7  
64-7R14 H 121,7  
64-7R24 H 161,7

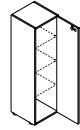

Sx  
64-7R05 H 81,7  
64-7R15 H 121,7  
64-7R25 H 161,7

Contenitore anta vetro\_Cabinet with glass  
door\_Schrank mit Glastüre\_Armoire porte  
vitrée\_Armario puerta acristalada

L45 P44  
64-7R09 H 81,7  
64-7R19 H 121,7  
64-7R29 H 161,7

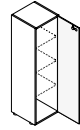

Ripiano per contenitori L45\_Cabinet shelf,  
L45\_Fachboden für Schrank L45\_Tablette  
pour armoires L45\_Estante para armarios  
L45

L41,3 P40 H2,2  
64-7R31 pezzi 1  
64-7R32 pezzi 2  
64-7R33 pezzi 3



Contenitore a giorno\_Open-fronted cabinet\_  
Armoire ouverte\_Armario sin puertas

L90 P43  
64-7R01 H 81,7  
64-7R11 H 121,7  
64-7R21 H 161,7

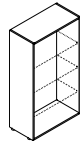

Contenitore ante legno\_Cabinet with  
wooden doors\_Armoire portes bois\_  
Armario puertas de madera

L90 P45  
64-7R02 H 81,7  
64-7R12 H 121,7  
64-7R22 H 161,7

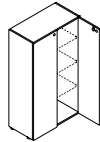

Contenitore ante vetro\_Cabinet with glass  
doors\_Armoire portes vitrées\_Armario  
puertas acristaladas

L90 P44  
64-7R03 H 81,7  
64-7R13 H 121,7  
64-7R23 H 161,7

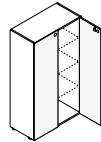

Ripiano per contenitori L90\_Cabinet shelf,  
L90\_Fachboden für Schrank L90\_Tablette  
pour armoires L90\_Estante para armarios  
L90

L86,3 P40 H2,2  
64-7R51 pezzi 1  
64-7R52 pezzi 2  
64-7R53 pezzi 3



Ripiano metallico per contenitori L90\_Metal  
shelf for cabinets, L90\_Metallfachboden für  
Schränke L90\_Tablette métallique pour  
armoires L90\_Estante metálico para  
armarios L90

L86,3 P40 H2,5  
54-9E51 pezzi 1



Classificatore con 2 cassetti, prof. 33\_Filing  
drawer box with 2 drawers, depth 33\_  
Aktensmöbel mit 2 Laden, Tiefe 33\_Classeur  
avec 2 tiroirs, prof. 33\_Carpetero con 2  
cajones, prof. 33

L90 P45 H81,7  
64-7R08



Anta per contenitori, con serratura\_Door for  
cabinets, with lock\_Tür für Schränke, mit  
Sperrung\_Porte pour armoires, avec  
serrure\_Puerta para armarios, con cerradura

L45 P2  
Dx  
64-7R82 H 81,7  
64-7R84 H 121,7  
64-7R86 H 161,7  
Sx  
64-7R92 H 81,7  
64-7R94 H 121,7  
64-7R96 H 161,7



Coppia ante, con serratura\_Pair of doors,  
with lock\_Türen (Paar), mit Sperrung\_Paire  
de portes, avec serrure\_Par de puertas, con  
cerradura

L90 P2  
64-7R62 H 81,7  
64-7R64 H 121,7  
64-7R66 H 161,7



Coppia ante per sovrapposizione\_Pair of  
doors for stacking\_Türen (Paar) für Montage  
übereinander\_Paire de portes pour  
superposition\_Par de puertas para  
sobreposición

L90 P2  
64-8R62 H 81,7  
64-8R64 H 121,7  
64-8R66 H 161,7

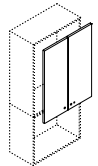

Top per contenitori\_Top for cabinets  
Schrankoberplatte\_Dessus pour armoires\_  
Encimera para armarios

P45 H1,8  
64-7R40 L 45  
64-7R41 L 90  
64-7R42 L 135  
64-7R45 L 180  
64-7R46 L 225  
64-7R47 L 270

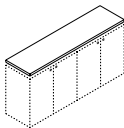

Cestone metallico con fondo\_Large metal  
basket with bottom\_Metallkorb mit Boden\_  
Casier métallique avec fond\_Gaveta  
metálica con fondo

L90-86 P33 H20  
53-CM05

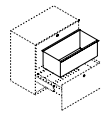

Pannello plexiglas\_Plexiglas screen panel\_  
Frontpaneel aus Plexiglas\_Panneau écran  
plexiglas\_Panel separador en plexiglas

H 30  
58-0L05 L 50  
58-0L07 L 70  
58-0L09 L 90  
58-0L11 L 110  
58-0L13 L 130  
58-0L15 L 150  
58-0L17 L 170

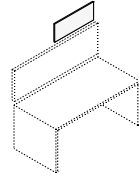

Vaschetta cancelleria alluminio\_Aluminium  
stationery tray\_Schale für Bürotensilien,  
Aluminium\_Bac plumier en aluminium\_  
Bandeja para útiles en aluminio

L22 P31 H8  
L32 P22 H8  
L44 P31 H8  
L66 P66 H8  
58-0L20  
58-0L21  
58-0L22  
58-0L23

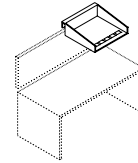

Vaschetta cancelleria plexiglas\_Plexiglas  
stationery tray\_Schale für Bürotensilien,  
Plexiglas\_Bac plumier en plexiglas\_Bandeja  
para útiles en plexiglas

L22 P31 H8  
L32 P22 H8  
58-0L25  
58-0L26

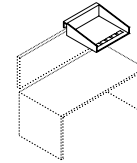

Accessorio reggilibri\_Book stand accessory\_  
Bücherständer\_Accessoire serre-livres\_  
Accessorio de soporte libros

L44  
58-0L40

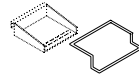

Cestello portacavi\_Cable rack\_Kabelkorb\_  
Corbeille porte-câbles\_Bandeja portacables

L40 P16,5 H5,5  
L96 P16,5 H5,5  
64-9R81  
64-9R82

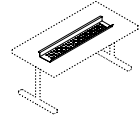

Supporto porta CPU\_Computer stand\_  
Computer-Auflageplatte\_Plateau pour  
ordinateur\_Soporte para ordenador

L60 P21 H52-47  
64-9R20

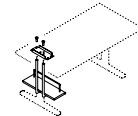

Canalina salita cavi\_Cable riser ducting\_  
Vertikale Kabelführung\_Conduit passe  
câbles\_Canal pasacables

Ø 6 H58  
53-9M88

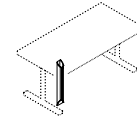

Canalina salita cavi\_Cable riser ducting  
Vertikale Kabelführung\_Conduit passe  
câbles\_Canal pasacables

Ø 6 H75  
55-9K75

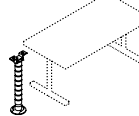

Ruota per tavoli con freno\_Caster for tables  
with brake\_Gebremste Rolle für Tische\_  
Roulette pour tables avec frein\_Rueda para  
mesas con freno

H6 Ø5  
64-9R35

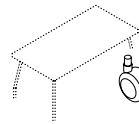

Set 4 ruote per cassettiere\_Set of casters for  
drawer boxes, 4pcs.\_Garnitur 4 Rollen für  
Schubladenkästen\_Jeu de 4 roulettes pour  
caissons\_Juego de 4 ruedas para cajoneras

H6 Ø 5  
54-9A40

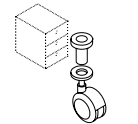

Elementi di collegamento\_Connecting  
elements\_Verbindungselemente\_Éléments  
de liaison\_Elements de union

64-9R31

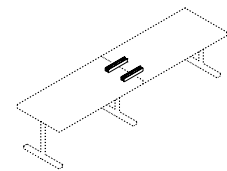

Coppia di collegamenti, piani a 90°\_Pair of  
connecting brackets, for 90° tops\_  
Halierungen für Platte 90° (Paar)\_Paire de  
supports pour plateaux à 90°\_Par de  
elementos de unión tapas a 90°

64-9R96

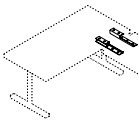

Coppia supporti per piani\_Pair of connecting  
brackets for tops\_Stützwinkel für Platten  
(Paar)\_Paire de supports pour plateaux\_Par  
de soportes para tapas

64-9R30

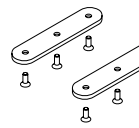

**Tavolo rettangolare** Rectangular table\_  
Rechteckiger Tisch\_Table rectangulaire\_  
Mesa rectangular

**BN** \_Bianco niveo\_Snow white\_  
Blanc neige\_Schneeweiß\_Blanco niebla



**BN** \_Bianco niveo\_Snow white\_  
Blanc neige\_Schneeweiß\_Blanco niebla



**GN** \_Grigio nebbia\_Misty grey\_  
Nebelgrau\_Gris brouillard\_Gris niebla



**GN** \_Grigio nebbia\_Misty grey\_  
Nebelgrau\_Gris brouillard\_Gris niebla



**RL** \_Rovere Galles \_Galles oak\_Waliser  
Eiche\_Chêne Galles \_Roble Galles



**Tavolo di servizio** Side table **Beistelltisch**  
**Table de service** Mesa de servicio

**BN** \_Bianco niveo\_Snow white\_



Blanc neige\_Schneeweiß\_Blanco niebla



**BN** \_Bianco niveo\_Snow white\_  
Blanc neige\_Schneeweiß\_Blanco niebla



**GN** \_Grigio nebbia\_Misty grey\_  
Nebelgrau\_Gris brouillard\_Gris niebla



**GN** \_Grigio nebbia\_Misty grey\_  
Nebelgrau\_Gris brouillard\_Gris niebla



**YL** \_Melaminico giallo\_Yellow melamine  
Gelb Melamin\_Mélaminé jaune\_  
Melaminico amarillo



**AT** \_Melaminico amaranto\_Amaranth  
melamine\_Amarantrot Melamin\_Mélaminé  
amarante\_Melaminico carmesi



**VP** \_Melaminico verde\_Green melamine  
Grün Melamin\_Mélaminé vert\_Melaminico  
verde



**VP** \_Melaminico verde\_Green melamine  
Grün Melamin\_Mélaminé vert\_Melaminico  
verde



**Cassettiera, 1cassetto\_1classif. Drawer box,**  
**1 drawer\_1 filing drawer\_Zwischentisch**  
**Caisson, 1 tiroir\_1 classeur\_Cajonera, 1**  
**cajón,1 carpetero**

**BN** \_Bianco niveo\_Snow white\_  
Blanc neige\_Schneeweiß\_Blanco niebla



**GN** \_Grigio nebbia\_Misty grey\_  
Nebelgrau\_Gris brouillard\_Gris niebla



**RL** \_Rovere Galles \_Galles oak\_Waliser  
Eiche\_Chêne Galles \_Roble Galles



**YL** \_Melaminico giallo\_Yellow melamine  
Gelb Melamin\_Mélaminé jaune\_  
Melaminico amarillo



**AT** \_Melaminico amaranto\_Amaranth  
melamine\_Amarantrot Melamin\_Mélaminé  
amarante\_Melaminico carmesi



**VP** \_Melaminico verde\_Green melamine  
Grün Melamin\_Mélaminé vert\_Melaminico  
verde



**Pannello schermo nobilitato\_Melamine**  
**screen panel\_Melamin-Abschirmpaneel\_**  
**Panneau écran mélaminé\_Panel separador**  
**melaminico**



**Pannello schermo nobilitato\_Melamine**  
**screen panel\_Melamin-Abschirmpaneel\_**  
**Panneau écran mélaminé\_Panel separador**  
**melaminico**



**Pannello schermo vetro sabbiato\_Matt-finish**  
**screen panel\_Abschirmpaneel aus Mattglas\_**  
**Panneau écran satiné\_Panel separador**  
**vidrio arenado**



**Pannello schermo vetro sabbiato\_Matt-finish**  
**screen panel\_Abschirmpaneel aus Mattglas\_**  
**Panneau écran satiné\_Panel separador**  
**vidrio arenado**



**Finiture**  
**Finishes**  
**Farben**  
**Finitions**  
**Acabados**

**Disponibilità di colori.**  
Nell'ambito di ogni collezione non tutti  
gli articoli sono disponibili nei vari colori  
e finiture. Per un esatto controllo della  
disponibilità è consigliato l'uso del  
catalogo tecnico.

**Colour availability.**  
Not all the articles in each collection are  
available in the full range of colours.  
Please consult the technical catalogue for  
the exact colours available.

**Verfügbare Farben.**  
Innerhalb der einzelnen Kollektionen sind  
nicht alle Artikel in allen Farben erhältlich,  
die angegeben sind. Um festzustellen,  
welche Farben jeweils verfügbar sind, bitte  
den technischen Katalog nachschlagen.

**Disponibilità de couleurs.**  
À l'intérieur de chaque collection, tous les  
articles ne sont pas disponibles dans les  
différentes couleurs énumérées. Pour un  
contrôle exact de la disponibilité, consulter  
le catalogue technique.

**Disponibilidad de colores.**  
En cada colección, no todos los artículos  
están disponibles en los distintos colores  
y acabados. Para controlar exactamente  
la disponibilidad se aconseja consultar  
el catálogo técnico.