

Sileo

Wall panels

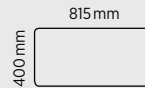
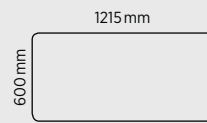
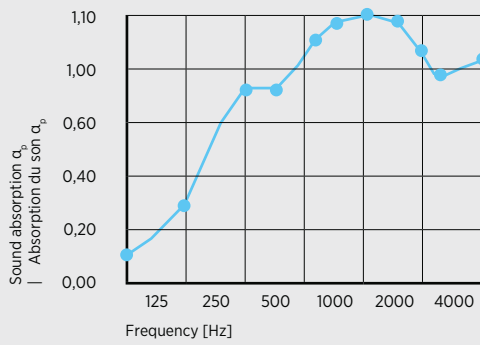
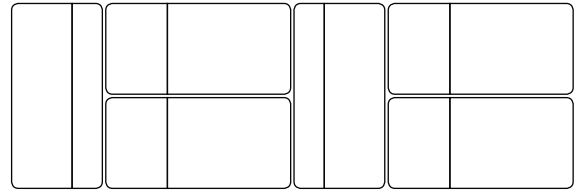
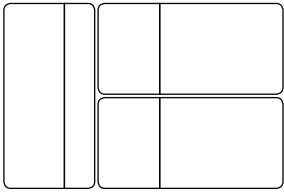

High tones

Thickness: 58 mm

Sileo S

Wall panels

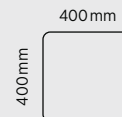
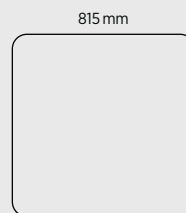
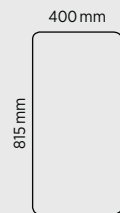
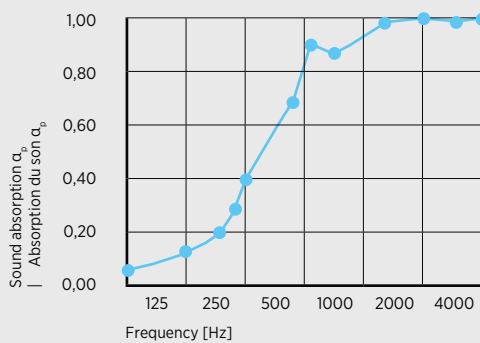
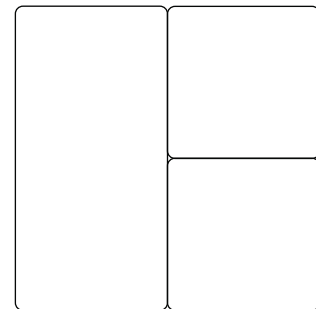
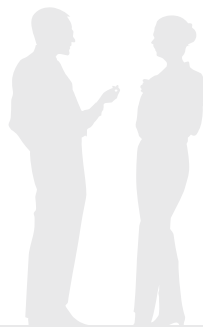
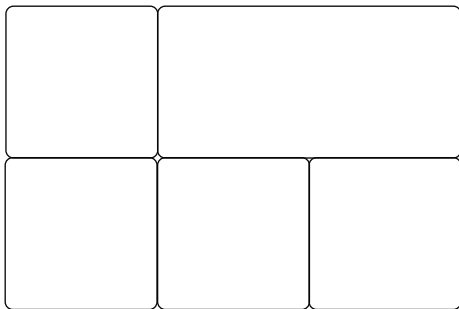

High tones

Thickness: 30 mm

Sileo

Ceiling suspended panels

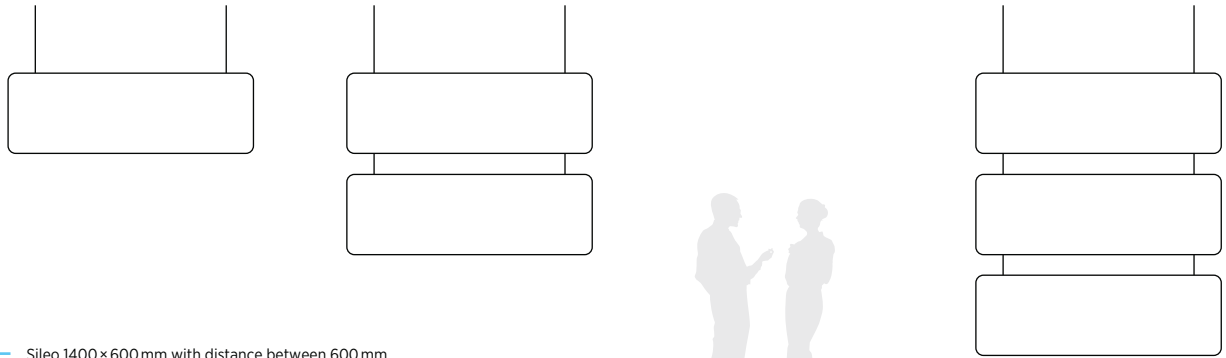

- Sileo 1400 × 600 mm with distance between 600 mm
- | Sileo 1400 × 600 mm, espacement de panneaux tous les 600 mm
- - - 1600 × 600 × 40

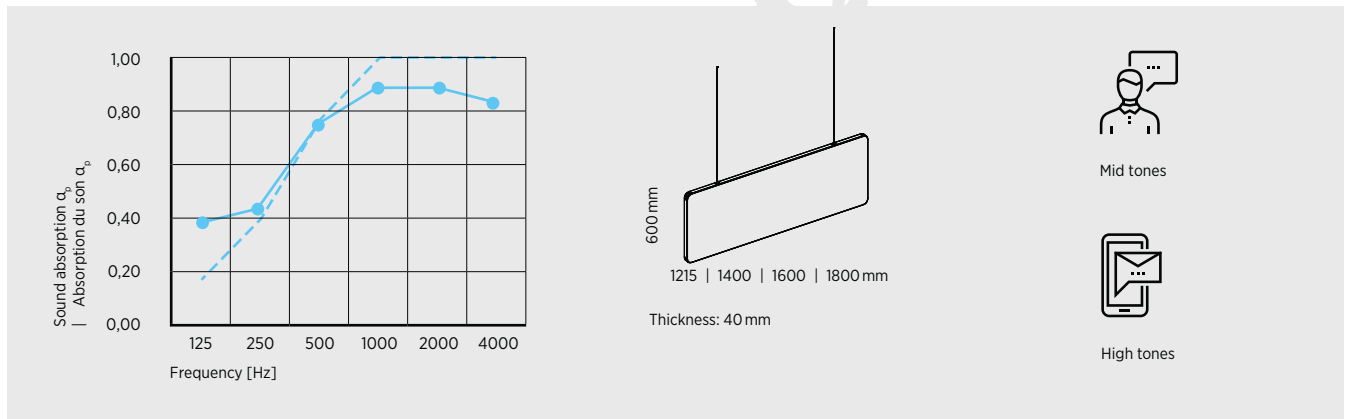

Sileo

Suspended panels – square island



Sileo S

Suspended panels - round island

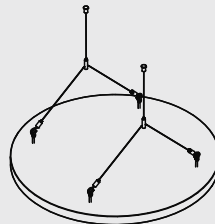
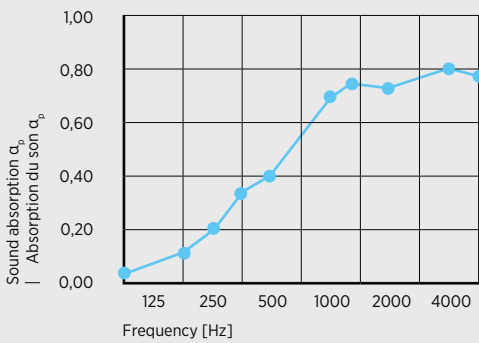

Ø800 mm | Ø600 mm
Thickness: 30 mm



High tones

Sileo

Desk and workbench screen panels

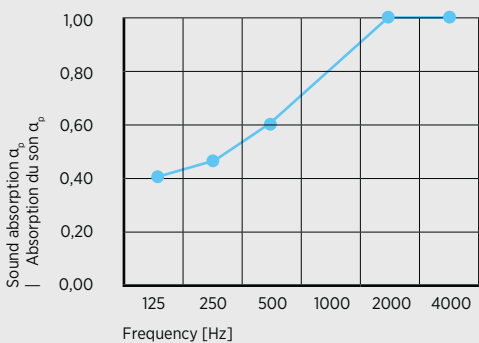
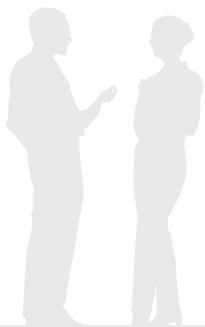

Desks & workbenches

1200 | 1400 | 1600 | 1800 mm

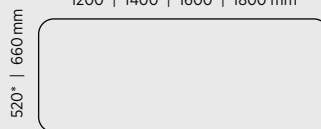

Thickness: 58 mm



Mid tones



High tones

*Workbenches

Sileo S

Desk and workbench screen panels

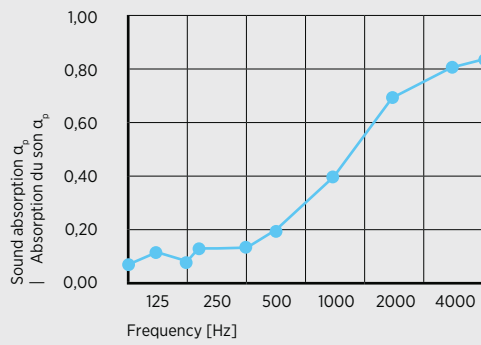

Desk
1200 | 1400 | 1600 | 1800 | 2000 mm*

660 mm

Thickness : 40 mm

Workbenches | postes « bench »
1200 | 1400 | 1600 | 1800 | 2000 mm*

Height:
520 | 560 | 607 | 700 | 737 mm

Thickness : 40 mm



High tones

*Except CS5040

Sileo

Mobile desk panel (side)

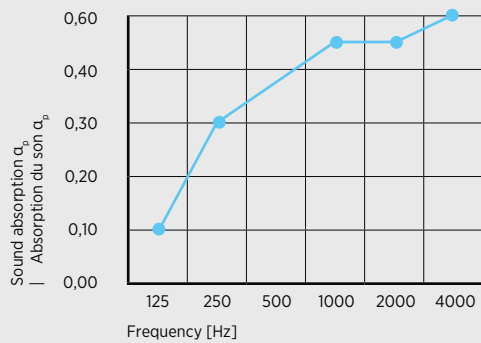
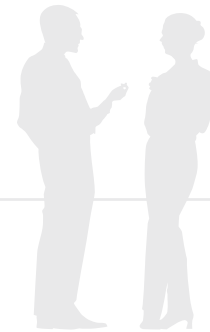
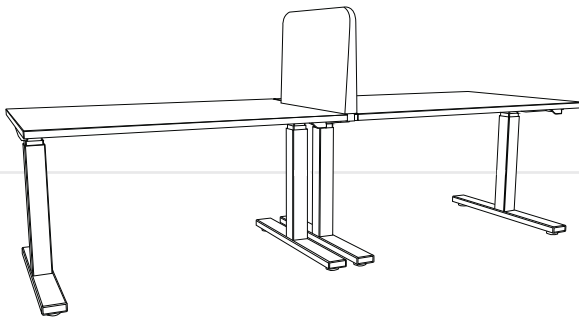

400 mm

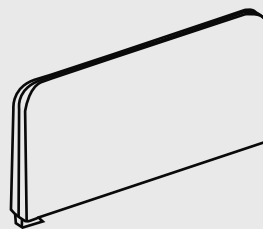

575 mm | 675 mm | 775 mm



High tones

Sileo S

Office walls

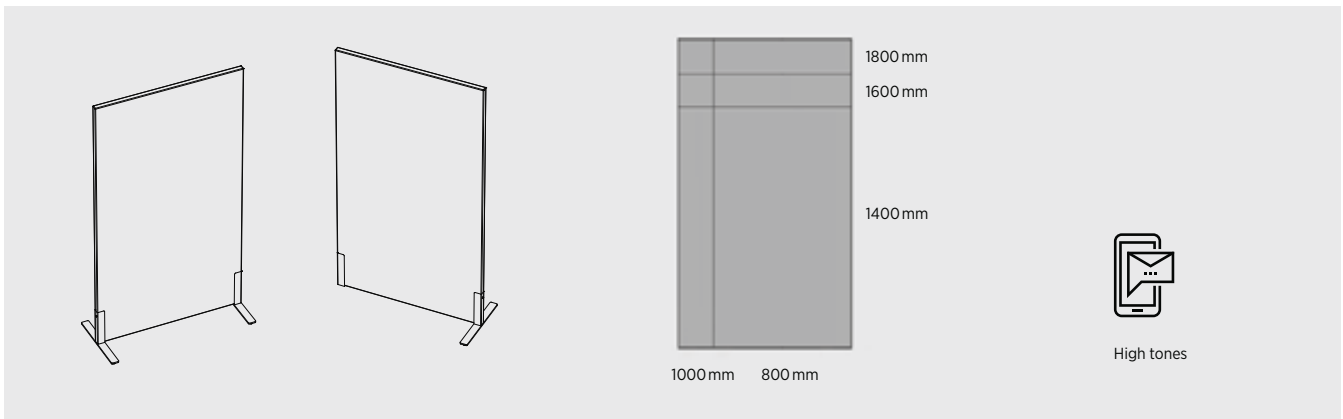
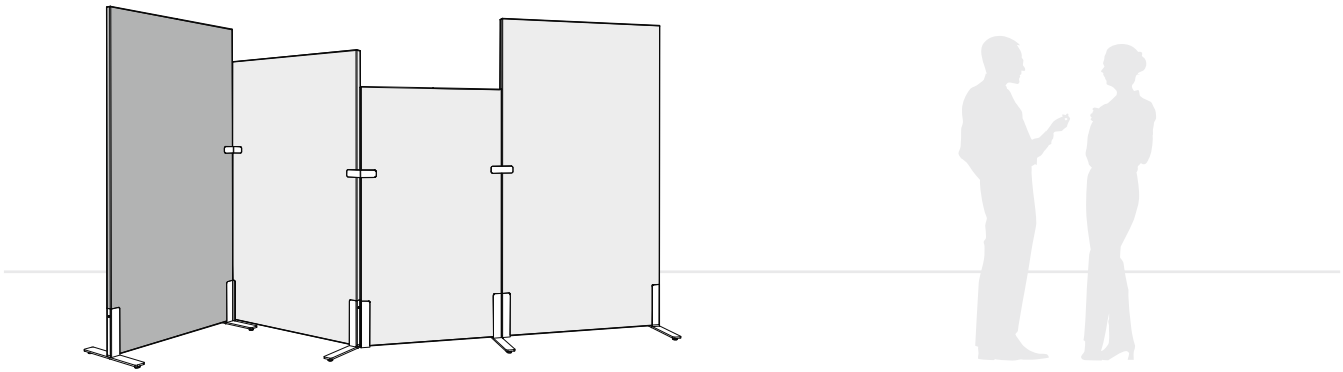

Sileo

Towers

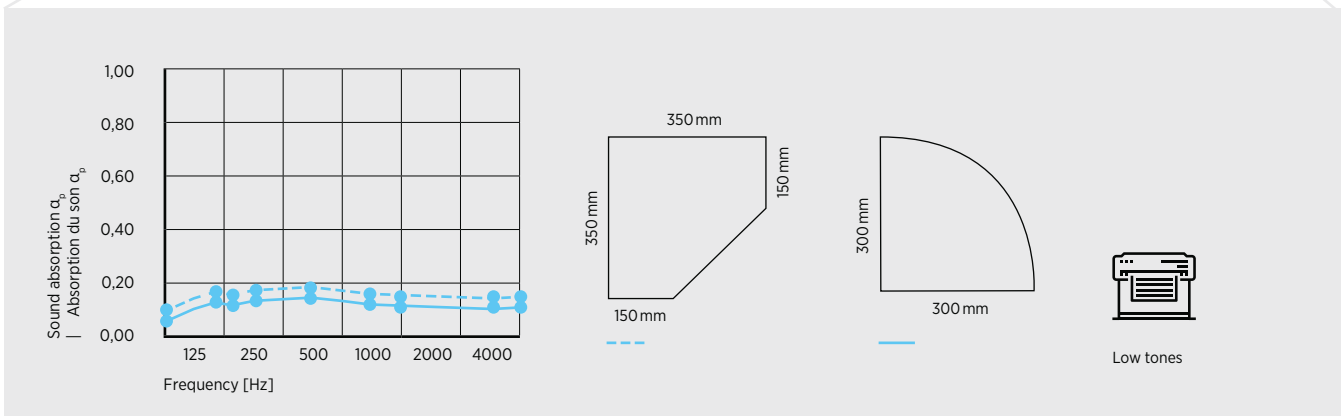
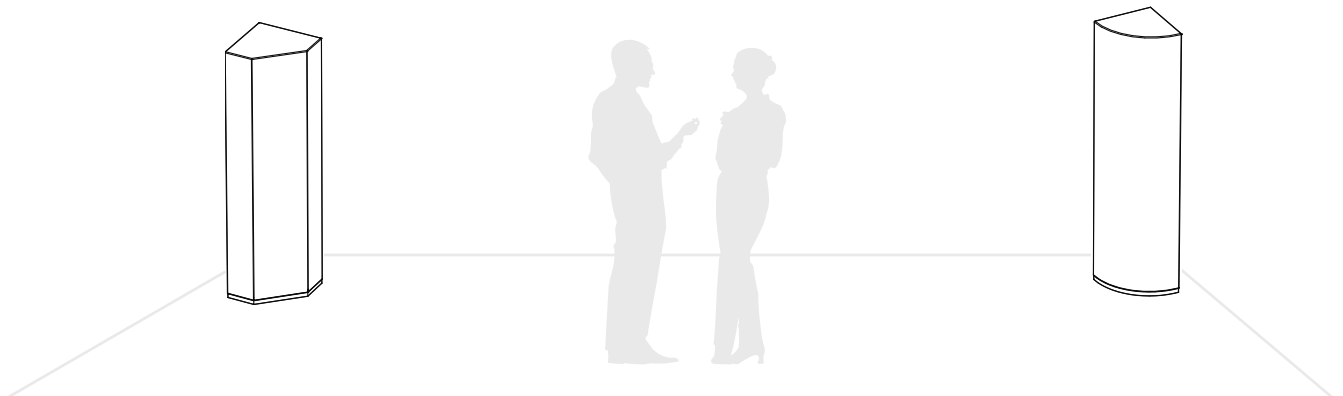

Sileo Pro

Premium panels

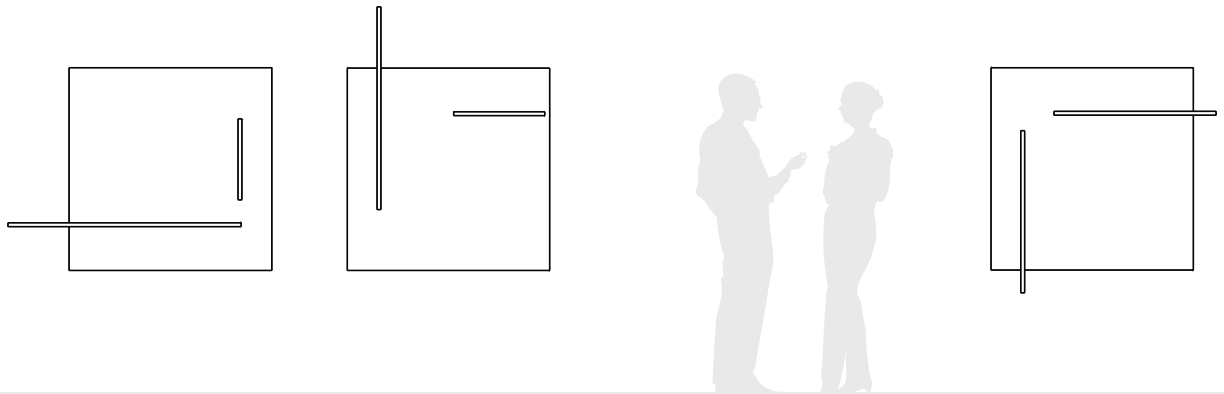

This section provides detailed dimensions for the panels. The first panel is 1000 mm wide and 1300 mm high. The second panel is 1110 mm wide and 1000 mm high. A vertical detail shows a thickness of 60 mm. To the right, icons represent 'Mid tones' (a person) and 'High tones' (a smartphone).

Sileo Levels

Perforated panels

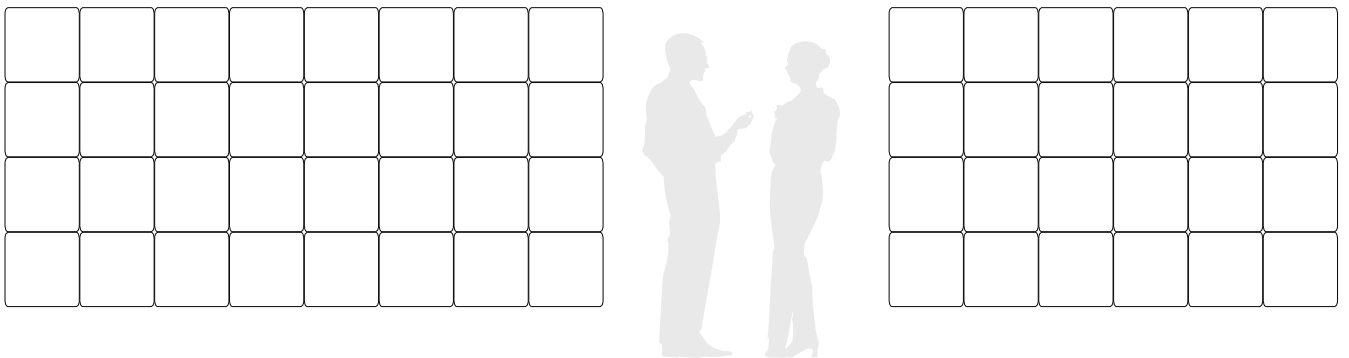

This section includes a graph of sound absorption α_p versus frequency [Hz]. The graph shows two curves: a solid line for 28 mm thickness and a dashed line for 58 mm thickness. To the right, a 400 mm square panel is shown with three thickness options: 28 mm, 58 mm, and 88 mm. Icons represent 'High tones' (a smartphone) and 'Low tones' (a printer), with 'Mid tones' (a person) also indicated.

Frequency [Hz]	Sound Absorption α_p (28 mm)	Sound Absorption α_p (58 mm)
125	0.10	0.30
250	0.20	0.70
500	0.50	0.90
1000	0.80	0.80
2000	0.70	0.30
4000	0.60	0.25